

# QUASAR

H O L L A N D



## Mira

NL Installatie handleiding

DE Installationsanleitung

EN Installation manual

# 1 NL Informatie / DE Information/ EN Information



## Veiligheidsinformatie

- Onderbreek altijd de stroomtoevoer door verwijderen van de toestelzijdige stop bij de montage, onderhoudswerk en het verwisselen van de gloeilampen.
- Een brandende lamp is heet. Let op brandgevaar.
- De lamp mag niet op geleidend materiaal worden gemonteerd.
- Draag geen sieraden bij onderhoudswerkzaamheden.
- Geen (decoratie) materialen aan het armatuur bevestigen.

## Technische informatie



- Ingangsspanning 120V of 240V
- Uitgangsspanning 12V
- Beschermingsklasse I
- Beschermingsgraad IP20
- De lamp mag niet in openlucht gebruikt worden
- LED: 12V, 0.6W, 2700K, CRI >90
- Ten minste een afstand van 0,5m tenopzichte van het bestraalde oppervlakte houden.
- Technische gelijkvormigheid volgens EN-Richtlijnen

## Sicherheitshinweise

- Bei Montage, Wartungsarbeiten und Leuchtmittelwechsel immer Stromzufuhr durch Entfernen der bauseitigen Sicherung unterbrechen.
- Wenn die Leuchte in Betrieb ist, besteht beim Glühmittel Verbrennungsgefahr!
- Leuchte darf nicht auf leitende Materialien montiert werden.
- Keine Juwelen während Wartung tragen.
- Keine (dekoration) Materialien an die Leuchte befestigen.

## Technische Hinweise

- Eingangsspannung 120V oder 240V
- Ausgangsspannung 12V
- Schutzklasse I
- Schutzart IP20
- Leuchte darf nicht im Freien verwendet werden.
- LED: 12V, 0.6W, 2700K, CRI >90
- Mindestabstand zur angestrahlten Fläche 0,5m
- Technische Konformität gemäss EU-Richtlinien

## Pflegehinweise

- Leuchten nur mit handelsüblichen, nicht aggressiven und scheuernden Reinigungsmitteln reinigen.
- Gebrauch eine Federbesen

## Safety information

- During installation, maintenance work and change of illuminants always interrupt the power supply by removing the respective circuit breaker.
- When switched on, the lamp may cause burns when touched.
- Lamp may not be mounted on conductive materials.
- Don't wear jewelry during maintenance.
- Don't use decoration materials in the lamp.

## Technical data

- Input voltage 120V or 240V
- Output voltage 12V
- Safety class I
- Degree of protection IP20
- Lamp must not be used in the open.
- LED: 12V, 0.6W, 2700K, CRI >90
- Minimum distance from illuminated surface 0.5m
- Technical conformity according to European EN-Regulations

## Onderhoudsinformatie



- De lampen reinigen met in de handel verkrijgbare, niet-agressieve en niet-schurende reinigingsmiddelen
- Gebruik een plumeau

## Maintenance information

- Lights should only be cleaned using commercially available, non-aggressive, non-scouring cleaning agents.
- Use a feather duster

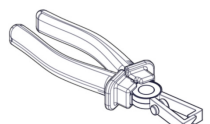
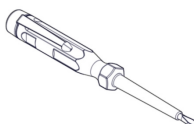
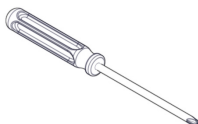
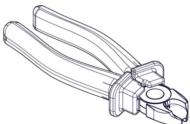
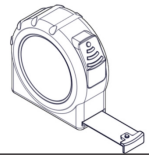
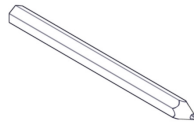
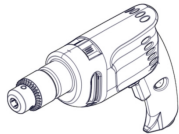
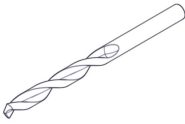

## 2 NL Optioneel dimmer instructies

---

### Dimmen

*Indien besteld met optionele dimmer dan is deze klaar voor gebruik.*

Met de afstandsbediening kunt u de lamp aan en uit schakelen.

Het dimmen gaat traploos van 0% tot 100%.

### Synchroniseren afstandsbediening en dimmodule

1. Zorg er altijd voor dat de stroom bij installatie van de dimmer uit staat!
2. Sluit de dimmodule aan volgens installatieschema.
3. Na het bedraden de stroom inschakelen. Druk op de inleerknop op de dimmodule, druk direct op een van de knoppen van de afstandsbediening, de lamp knippert nu twee keer en is gebruiksklaar.

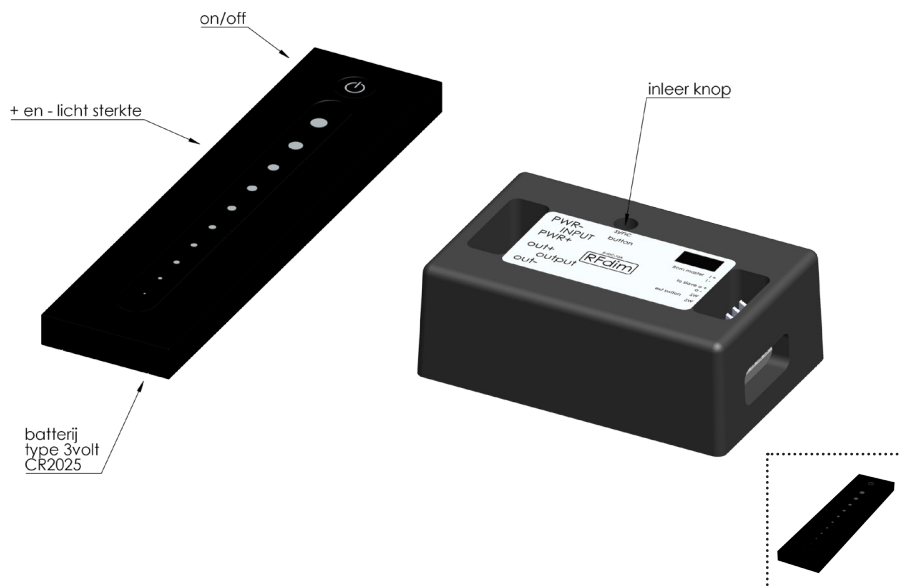

### 3 EN Optional dimming instruction

---

#### Dimming

*If ordered with the optional dimmer, the dimmer is ready to use and programmed.*

The fixture can be switched on and off with the remotecontrol.

The dimming is adjustable from 0% to 100%.

#### Synchronising remotecontrol and dimmodule

1. Switch off the power
2. Connect the dimmodule according to wiringdiagram.
3. Switch on power. Push the programmingbutton , push immediately on one of the buttons of the remotecontrol. The fixture blinks 2 times and is ready for use.

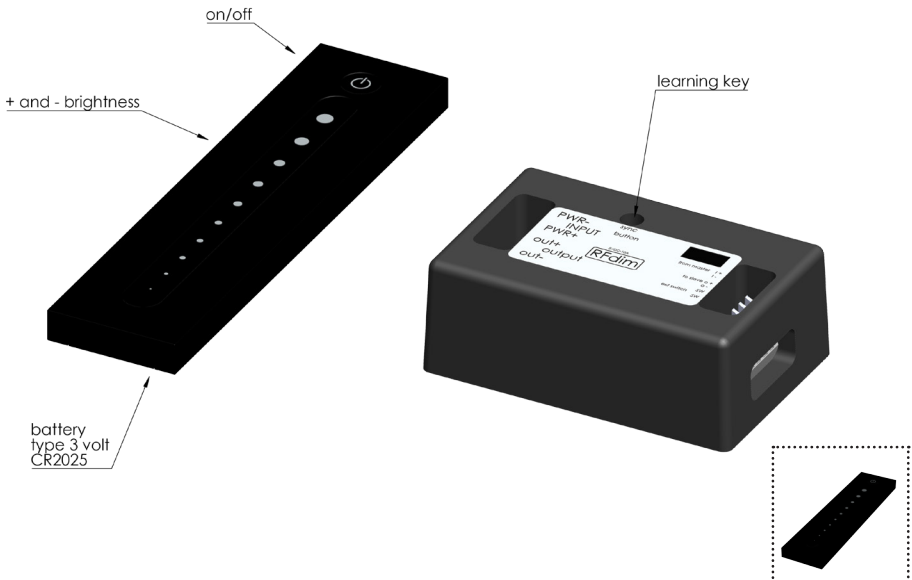

## 4 DE Optional anweisungen für dimmen

---

### Dimmen

*Falls mit Option Dimmer bestellt wird, ist der Dimmer fertig und programmiert.*

Die Leuchte kann an- und ausgeschaltet werden mit den Fernbedienung.  
Stufenlos dimmbar von 0% bis 100%.

### Synchronisieren vom Fernbedienung und Dimmodul

1. Strom ausschalten
2. Dimmodul anschliessen laut verdrahtungsdiagram.
3. Strom anschalten. Programtaste eindrücken. Gleich einer Taste vom Fernbedienung drücken. Die Leuchte blinkt 2 Mal und is fertig.

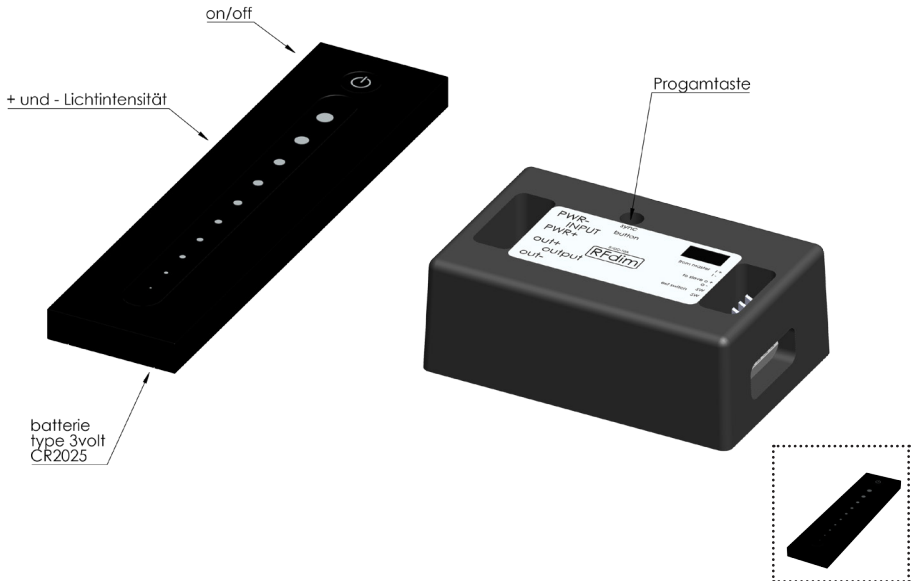

## 5.1 NL Installatie / EN Installation / DE Installation

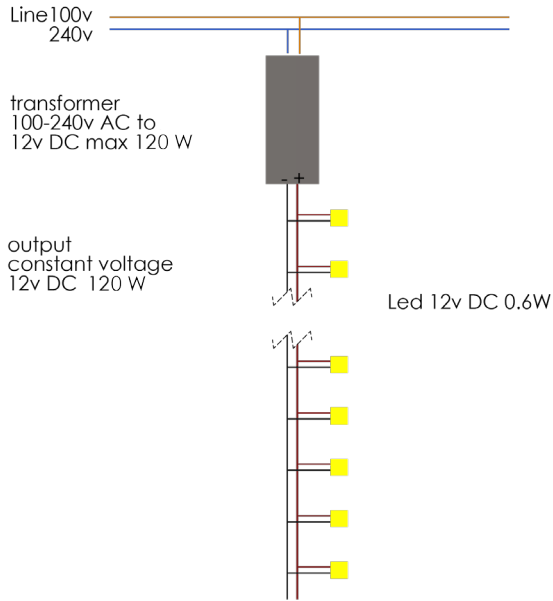

## 5.2

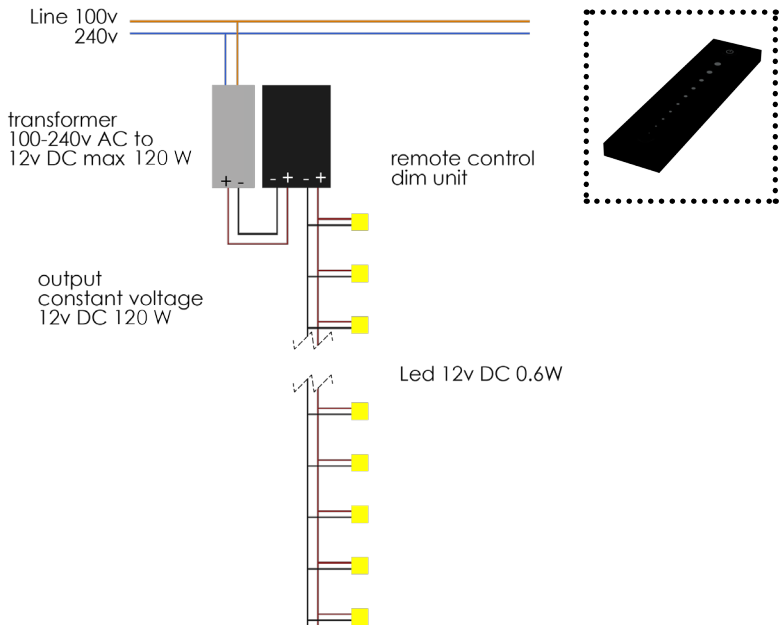

### 5.3 NL Installatie / EN Installation / DE Installation

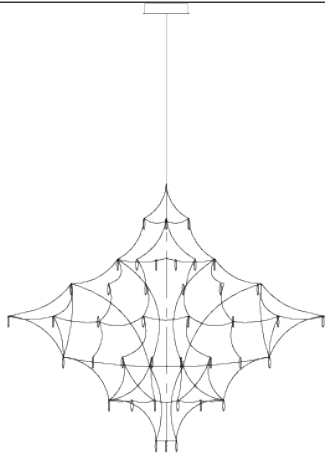

D

#### **D = 80cm**

- 39x LED E10 12V/0,6W= 23,4W

#### **D = 100cm**

- 57x LED E10 12V/0,6W= 34,2W

#### **D = 120cm**

- 72x LED E10 12V/0,6W= 43,2W

#### **D = 140cm**

- 93x LED E10 12V/0,6W= 55,8W

#### **D = 160cm**

- 114x LED E10 12V/0,6W= 68,4W

#### **D = 180cm**

- 141x LED E10 12V/0,6W= 84,6W

#### **D = 200cm**

- 171x LED E10 12V/0,6W= 102,6W

#### **D = ...cm**

- ...x LED E10 12V/0,6W= ...W

### 5.4

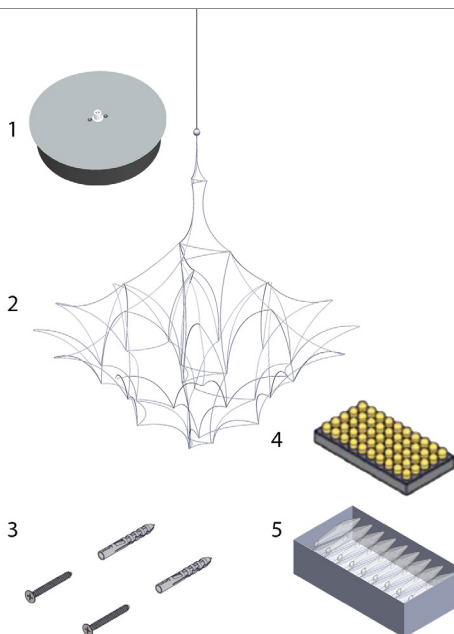
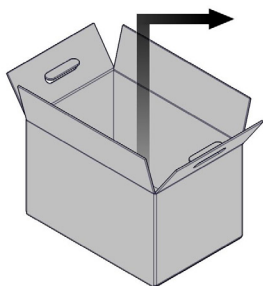

5.5 NL Installatie / EN Installation / DE Installation

---

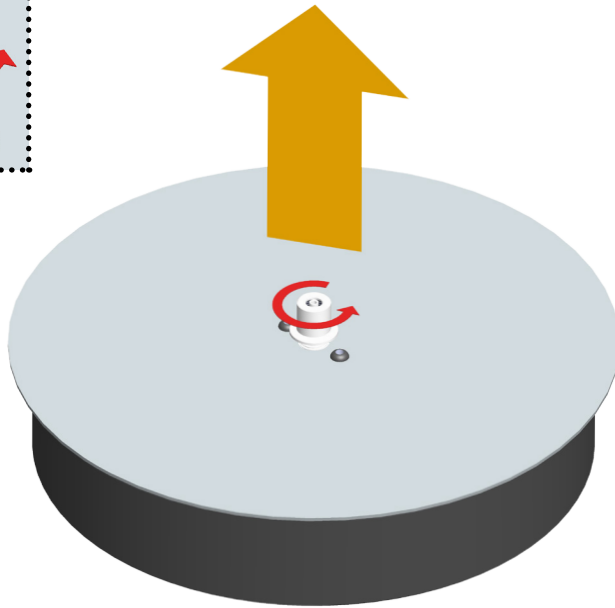

---

5.6

---

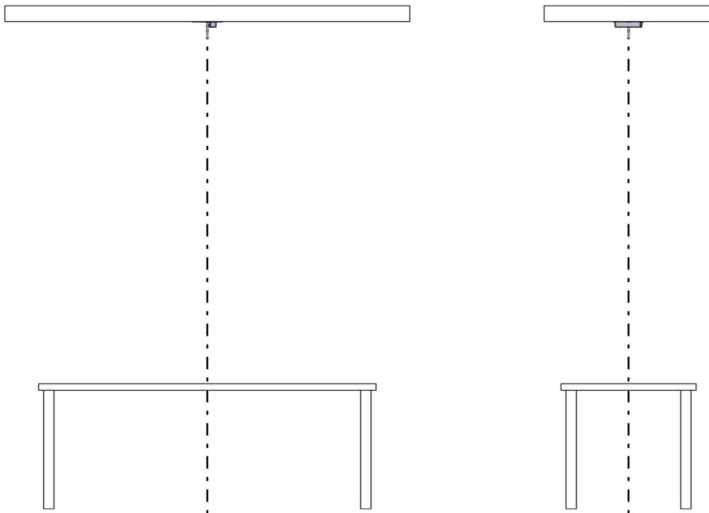



## 5.7 NL Installatie / EN Installation / DE Installation

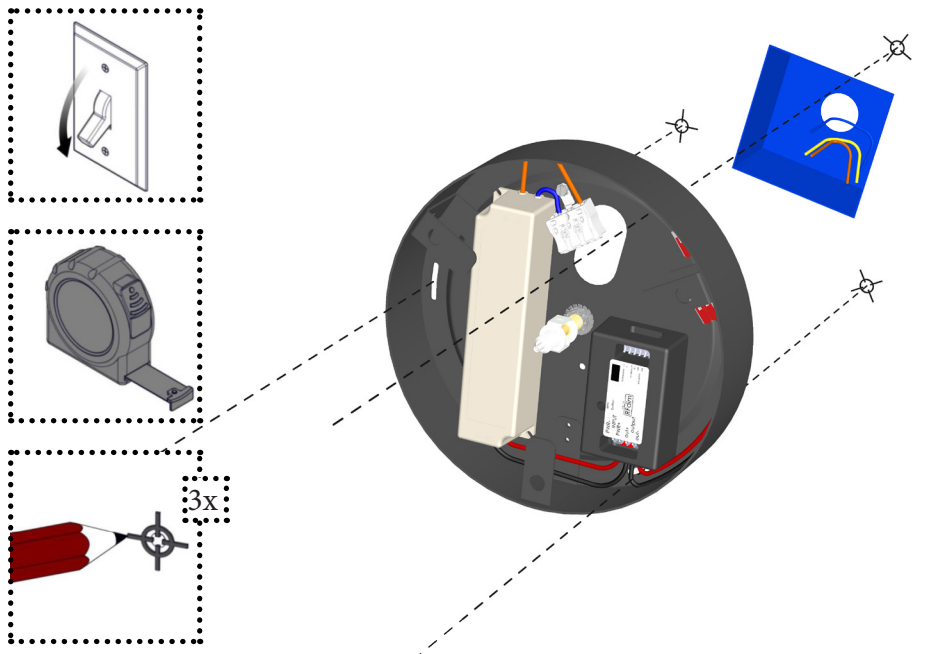

## 5.8

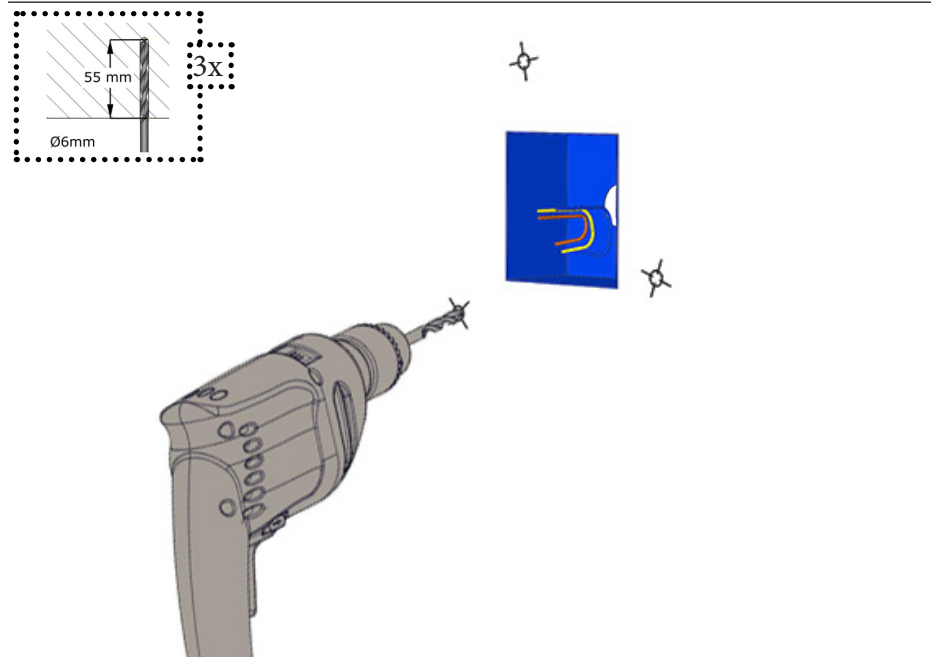

## 5.9 NL Installatie / EN Installation / DE Installation

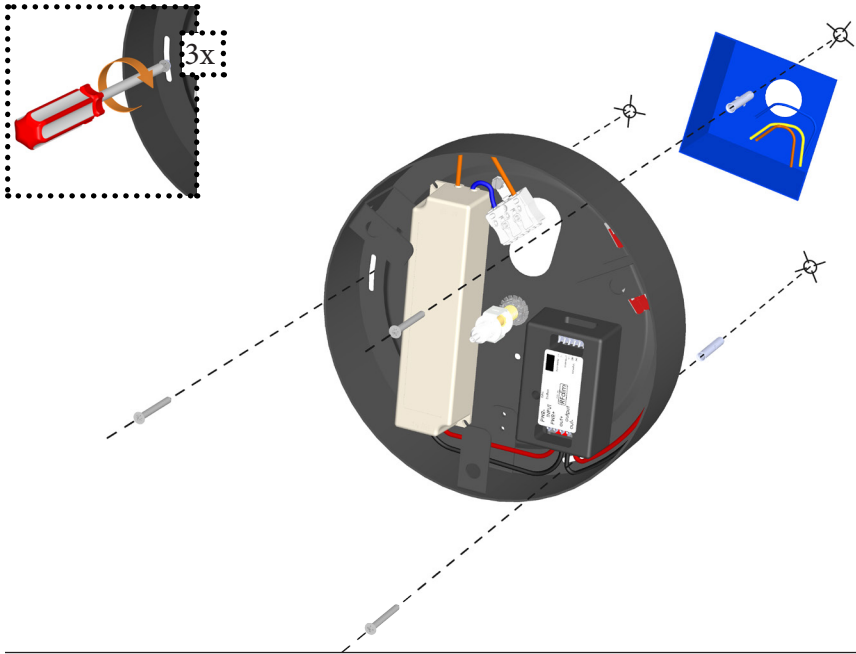

## 5.10

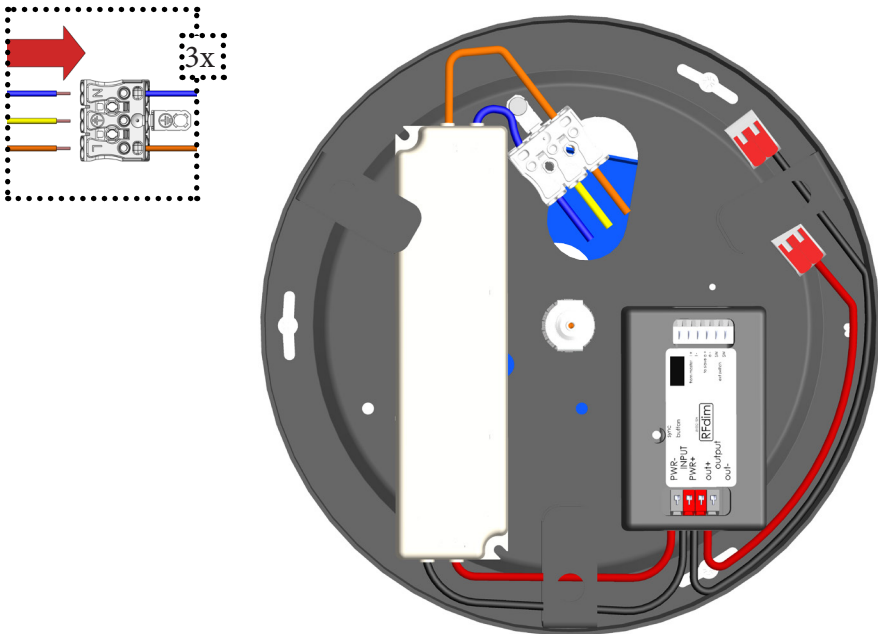

5.11 NL Installatie / EN Installation / DE Installation

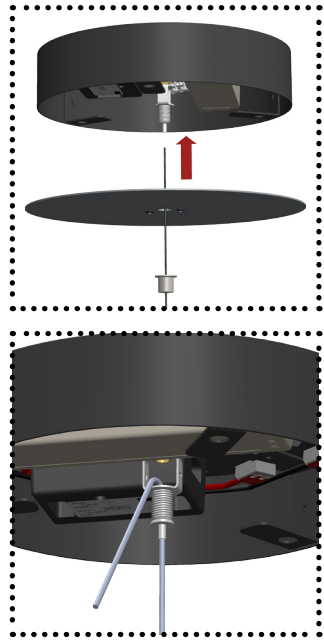
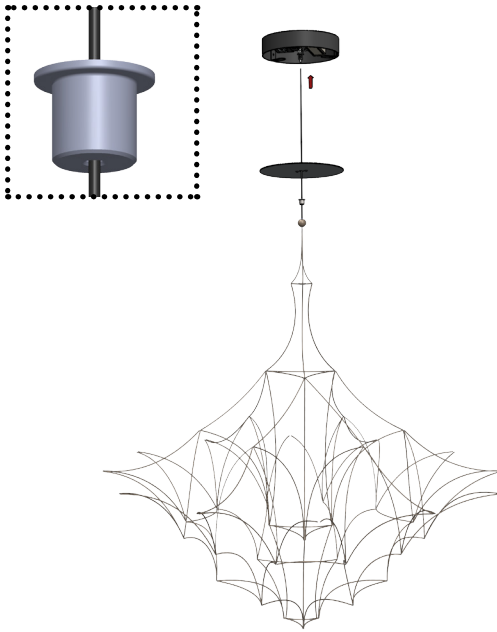

5.12

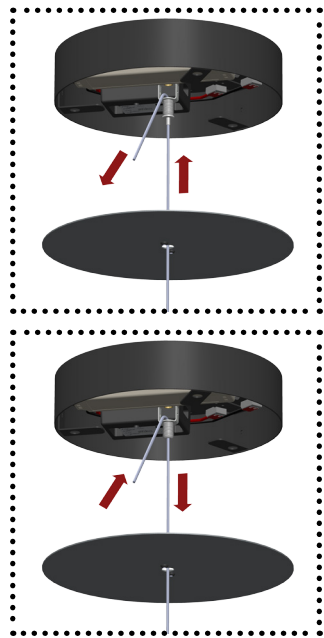
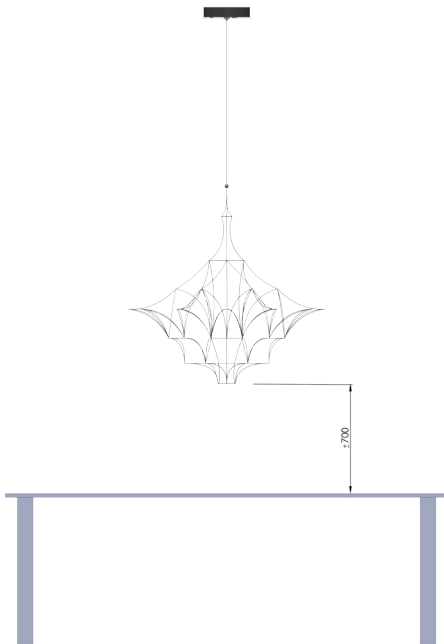

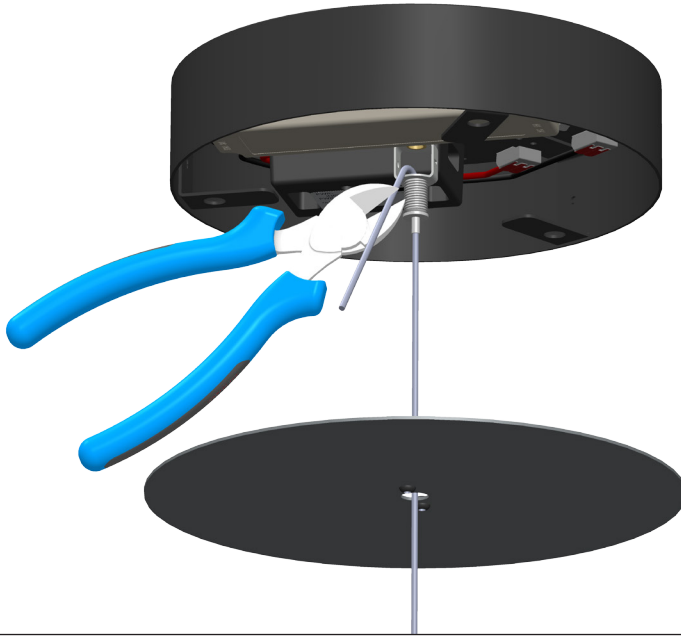

## 5.15 NL Installatie / EN Installation / DE Installation

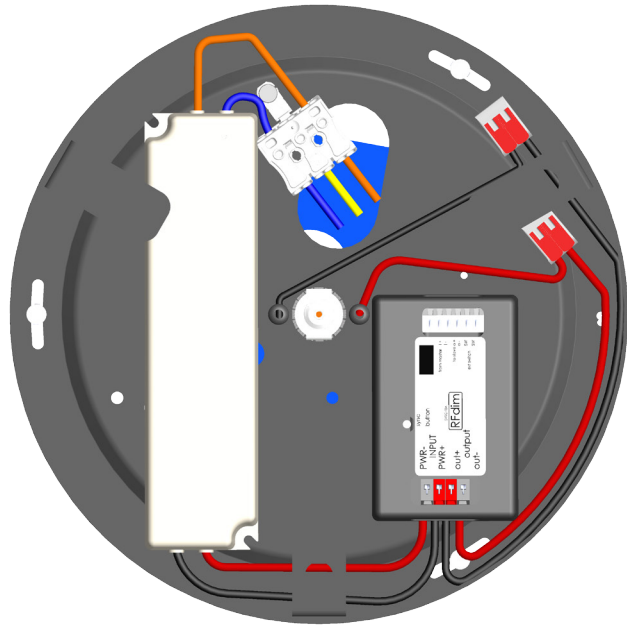
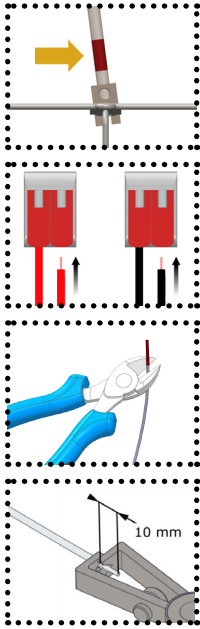

## 5.16

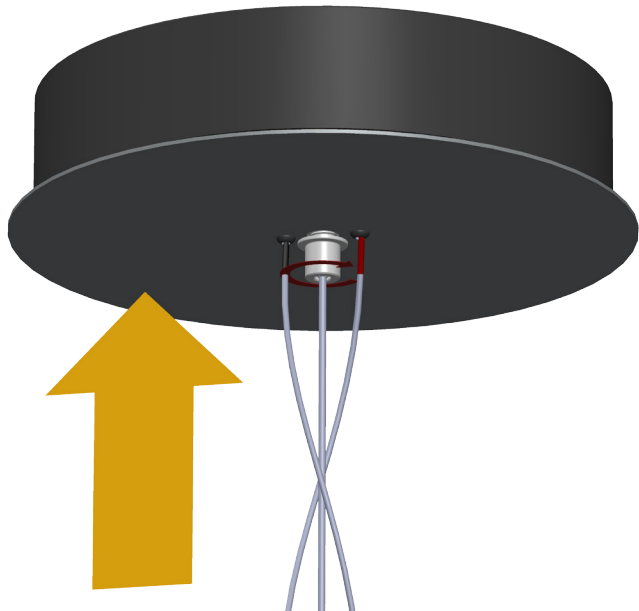

5.17 NL Installatie / EN Installation / DE Installation

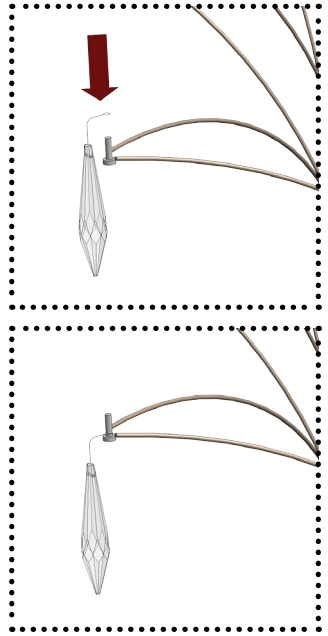

5.18

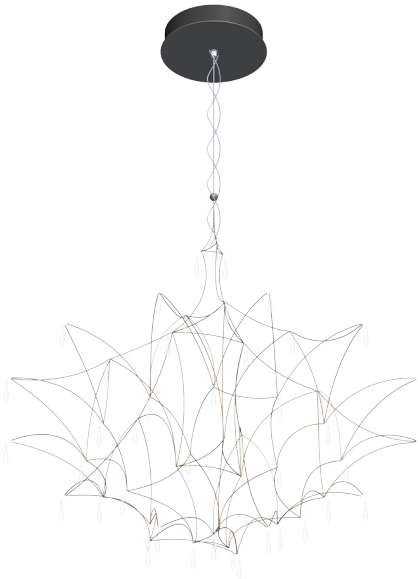
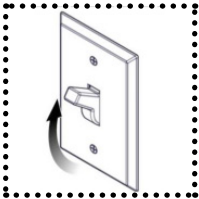
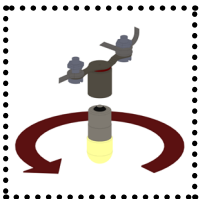

Lined writing area consisting of 25 horizontal lines.



Quasar Holland B.V.  
Burgstraat 2  
4283 GG GIESSEN  
THE NETHERLANDS

T. 31-183-447887  
E. [info@quasar.nl](mailto:info@quasar.nl)  
I. [www.quasar.nl](http://www.quasar.nl)

Date: 07-12-2021  
Version: 3